

HR-Robus

Industrial Door Microwave Motion Sensor

INSTALLATION INSTRUCTIONS

Section 1

General Description

The HR-Robus is a microwave motion sensor for activating automatic industrial doors. Features include a speed selectable switch that makes the unit capable of detecting pedestrians and/or vehicles. Detection mode is selectable between approach-only, depart-only, or bidirectional motion.

Microwave technology allows the HR-Robus to detect larger objects, such as forklift trucks, up to 26.3 feet away. Maximum pattern size is approximately 16.4 feet wide at 26.3 feet from the unit, at a mounting height of 23 feet, and is adjustable via programming, tilt angle, and mounting height. The HR-Robus is not affected by air motion, change in temperature, humidity, color or background variations.

Section 2

Parts Identification

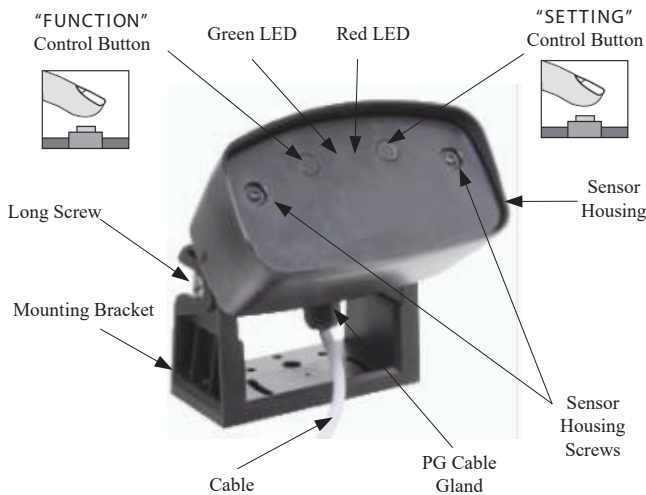

Included

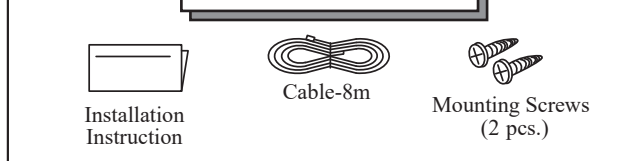

Section 3

Installation

Mounting

1. Mount the sensor at 23 ft. (7m) or lower.

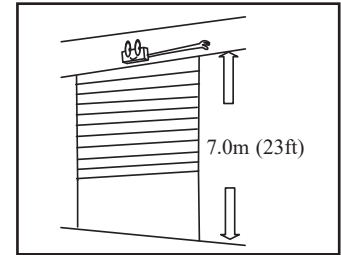

2. Drill mounting holes as shown below.

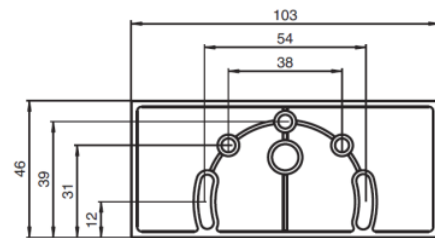

WARNING: Drilling may cause electric shock. Be careful of hidden wires.

3. Loosen the long screw and separate the mounting bracket from the sensor housing. (There is no need to remove the long screw).

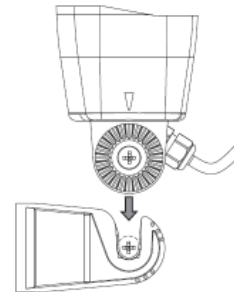

4. Attach the mounting bracket with the mounting screws provided.

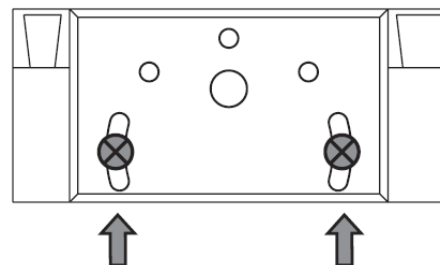

HR-Robus

Industrial Door Microwave Motion Sensor

INSTALLATION INSTRUCTIONS

- Re-insert the sensor housing into the mounting bracket and set the desired sensor housing angle, then tighten the long screw and connect the cable to the door controller.

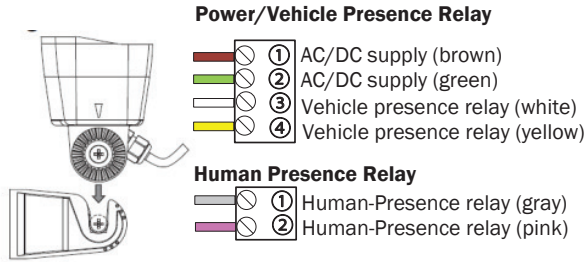

WARNING: Incorrect voltage may damage the sensor or cause electric shock.

- Ensure there are no moving objects or fluorescent lights in the detection zone.

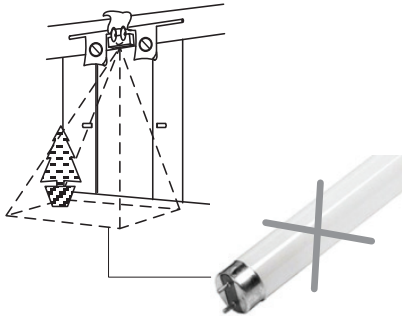

- Apply power to the device. The sensor LEDs will flash RED/GREEN for 10 seconds indicating that the hardware and software have been initialized. Once this is complete, the sensor settings can be configured as required.

Section 4 LED Indicators

Red/Green Flashing..... Sensor Initialization
 Green.....Standby
 Green Flashing (Fast)... Human Presence relay activated
 Red Flashing (Fast).....Vehicle Presence relay activated
 Red/Green
 Flashing (fast)..... Vehicle Presence relay and
 Human Presence relay activated

Number of Red flashes (slow) followed by a number of Green flashes (slow) indicates the sensor function and the setting for that function during sensor programming using the control buttons on the sensor body.

Section 5 Pattern Adjustments

Detection Area Width and Depth Adjustment

- When the long screw is loosened, the sensor housing can be moved up/down in increments of 15° to give the desired detection area. Re-tighten the long screw when the desired sensor housing angle is achieved.

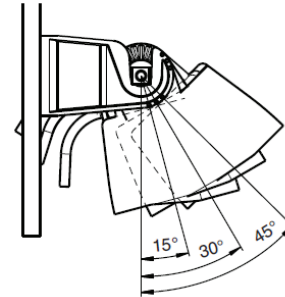

- The mounting bracket can be installed at an incline to focus the sensor detection area to the right or left or as required.

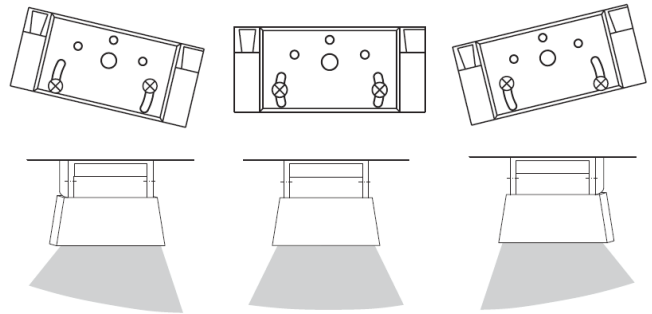

Section 6 Programming the Sensor

The HR-Robus can be programmed using the “FUNCTION” and “SETTING” control buttons on the front of the sensor.

Press and hold the “FUNCTION” button for 2 seconds or longer to enter programming mode.

Once programming mode is entered, the number of RED LED flashes (slow) indicates the function to be set from 1 to 9 as shown in the table in Section 8. The corresponding number of GREEN LED flashes (slow) indicates the current setting for that function.

For example, one RED LED flash (slow) indicates the sensitivity function followed by six GREEN LED flashes (slow) indicates a sensitivity value of 6 on the 1-10 scale.

Using the “FUNCTION” control button, toggle through the nine functions until you reach the one that you would

HR-Robus

Industrial Door Microwave Motion Sensor

INSTALLATION INSTRUCTIONS

like to change. Then toggle the “SETTING” control button to set your desired value for that function which will be confirmed by the number of GREEN LED flashes.

Each time the “SETTING” control button is pressed, the setting is automatically stored.

Exit the programming mode by pressing and holding the “FUNCTION” button for 2 seconds.

Section 7

Programming Example

Changing Relay Hold Time from 1 to 5 seconds.

1. Press and hold the “FUNCTION” button for 2 seconds to enter programming mode.
2. The current “FUNCTION” (RED LED) and “SETTING” (GREEN LED) will be indicated by the sequence of red and green LED flashes. For example, 1xRED for function followed by 8xGREEN highlights a sensitivity setting of 8.
3. Press the “FUNCTION” button 5 times to toggle down to the Relay Hold Time function. The red LED should now be flashing six times with the number of green LED flashes indicating the current setting for Relay Hold Time. For example, two green flashes indicates a Relay Hold Time setting of 1 second.
4. To change the Relay Hold Time from 1 second to 5 seconds, press the “SETTING” button four times.
5. Six RED LED flashes followed by six GREEN LED flashes will now indicate that the Relay Hold Time is set to 5 seconds.
6. Press and hold the “FUNCTION” button for two seconds to exit programming mode and save sensor settings.

Section 8

Programmable Parameters

Using sensor control buttons

NOTE: The product is designed to distinguish between vehicles and people. This distinction is dependent on the settings of the “Vehicle Detection”, “Human-Presence Detection”, and “Responsiveness” parameters.

To enter and exit programming mode, press and hold the FUNCTION button for approximately two seconds.

◆ = Indicates default factory settings

After changing sensor settings, confirm them by walk testing the sensor.

SEE TABLE 1 FOR PROGRAMMABLE PARAMETERS



HR-Robus

Industrial Door Microwave Motion Sensor

INSTALLATION INSTRUCTIONS

TABLE 1
Programmable Parameters





FUNCTION	SETTINGS	DESCRIPTION	SETTING RECOMMENDATIONS	REMOTE CONTROL SETTING POSSIBLE																																																										
1	Sensitivity Number of red LED flashes from 1-9 indicate the function	Number of green LED flashes indicate the setting for each function	<table border="1"> <thead> <tr> <th rowspan="2">Installation Height</th> <th colspan="4">Sensor Housing Angle</th> </tr> <tr> <th>15°</th> <th>30°</th> <th>45°</th> <th>>45°</th> </tr> </thead> <tbody> <tr> <td>7m</td> <td>8</td> <td>4</td> <td>2</td> <td>1</td> </tr> <tr> <td>5m</td> <td>6</td> <td>6</td> <td>3</td> <td>1</td> </tr> <tr> <td>3.5m</td> <td>6</td> <td>5</td> <td>4</td> <td>1</td> </tr> <tr> <td>2.5m</td> <td>4</td> <td>4</td> <td>4</td> <td>1</td> </tr> </tbody> </table>	Installation Height	Sensor Housing Angle				15°	30°	45°	>45°	7m	8	4	2	1	5m	6	6	3	1	3.5m	6	5	4	1	2.5m	4	4	4	1	✓																													
Installation Height	Sensor Housing Angle																																																													
	15°	30°	45°	>45°																																																										
7m	8	4	2	1																																																										
5m	6	6	3	1																																																										
3.5m	6	5	4	1																																																										
2.5m	4	4	4	1																																																										
2	Vehicle Detection	1 Smallest Detection Area 2 3 4 5 6 ♦ 7 8 9 10 Largest Detection Area	<table border="1"> <thead> <tr> <th rowspan="2">Installation Height</th> <th colspan="4">Sensor Housing Angle</th> </tr> <tr> <th>15°</th> <th>30°</th> <th>45°</th> <th>>45°</th> </tr> </thead> <tbody> <tr> <td>7m</td> <td>1</td> <td>2</td> <td>2</td> <td>1</td> </tr> <tr> <td>5m</td> <td>1</td> <td>2</td> <td>2</td> <td>2</td> </tr> <tr> <td>3.5m</td> <td>1</td> <td>2</td> <td>2</td> <td>3</td> </tr> <tr> <td>2.5m</td> <td>1</td> <td>2</td> <td>2</td> <td>3</td> </tr> </tbody> </table>	Installation Height	Sensor Housing Angle				15°	30°	45°	>45°	7m	1	2	2	1	5m	1	2	2	2	3.5m	1	2	2	3	2.5m	1	2	2	3	✓																													
Installation Height	Sensor Housing Angle																																																													
	15°	30°	45°	>45°																																																										
7m	1	2	2	1																																																										
5m	1	2	2	2																																																										
3.5m	1	2	2	3																																																										
2.5m	1	2	2	3																																																										
3	Human Presence Detection	1 Low 2 Medium ♦ 3 High	<p>Detection without cross-traffic suppression</p> <table border="1"> <thead> <tr> <th rowspan="2">Installation Height</th> <th colspan="4">Sensor Housing Angle</th> </tr> <tr> <th>15°</th> <th>30°</th> <th>45°</th> <th>>45°</th> </tr> </thead> <tbody> <tr> <td>7m</td> <td>1</td> <td>1</td> <td>1</td> <td>1</td> </tr> <tr> <td>5m</td> <td>1</td> <td>1</td> <td>1</td> <td>1</td> </tr> <tr> <td>3.5m</td> <td>1</td> <td>1</td> <td>1</td> <td>1</td> </tr> <tr> <td>2.5m</td> <td>1</td> <td>1</td> <td>1</td> <td>1</td> </tr> </tbody> </table> <p>Detection with cross-traffic suppression</p> <table border="1"> <thead> <tr> <th rowspan="2">Installation Height</th> <th colspan="4">Sensor Housing Angle</th> </tr> <tr> <th>15°</th> <th>30°</th> <th>45°</th> <th>>45°</th> </tr> </thead> <tbody> <tr> <td>7m</td> <td>4-7</td> <td>2-7</td> <td>2-7</td> <td>2-7</td> </tr> <tr> <td>5m</td> <td>4-7</td> <td>4-7</td> <td>4-7</td> <td>4-7</td> </tr> <tr> <td>3.5m</td> <td>4-7</td> <td>4-7</td> <td>6-7</td> <td>6-7</td> </tr> <tr> <td>2.5m</td> <td>4-7</td> <td>6-7</td> <td>6-7</td> <td>6-7</td> </tr> </tbody> </table>	Installation Height	Sensor Housing Angle				15°	30°	45°	>45°	7m	1	1	1	1	5m	1	1	1	1	3.5m	1	1	1	1	2.5m	1	1	1	1	Installation Height	Sensor Housing Angle				15°	30°	45°	>45°	7m	4-7	2-7	2-7	2-7	5m	4-7	4-7	4-7	4-7	3.5m	4-7	4-7	6-7	6-7	2.5m	4-7	6-7	6-7	6-7	✓
Installation Height	Sensor Housing Angle																																																													
	15°	30°	45°	>45°																																																										
7m	1	1	1	1																																																										
5m	1	1	1	1																																																										
3.5m	1	1	1	1																																																										
2.5m	1	1	1	1																																																										
Installation Height	Sensor Housing Angle																																																													
	15°	30°	45°	>45°																																																										
7m	4-7	2-7	2-7	2-7																																																										
5m	4-7	4-7	4-7	4-7																																																										
3.5m	4-7	4-7	6-7	6-7																																																										
2.5m	4-7	6-7	6-7	6-7																																																										
4	Vehicle Presence Relay	1 Vehicle forward ♦ 2 Vehicle backwards 3 Vehicle forward/backwards 4 Person/vehicle forward 5 Person/vehicle backwards 6 Person/vehicle forwards/backwards		✓																																																										
5	Human Presence Relay	1 Person forward ♦ 2 Person backwards 3 Person forward/backwards 4 Vehicle forward 5 Vehicle backwards 6 Vehicle forwards/backwards		✓																																																										
6	Relay Hold Time	1 0.5s 8 15s 2 1s ♦ 9 20s 3 2s 10 25s 4 3s 11 30s 5 4s 12 60s 6 5s 13 300s 7 10s	The amount of time the relay stays active once activated	✓																																																										
7	Relay Contact	1 N.O. Contact ♦ 2 N.C. Contact	 N.O. Contact  Closes on detection  N.C. Contact  Opens on detection	✓																																																										





TABLE 1 - (continued)
Programmable Parameters

FUNCTION	SETTINGS	DESCRIPTION	SETTING RECOMMENDATIONS	REMOTE CONTROL SETTING POSSIBLE								
8	Responsive-ness 1 Fast 2 Normal ♦ 3 Slow		<table border="1"> <thead> <tr> <th>Behavior</th> <th>Setting</th> </tr> </thead> <tbody> <tr> <td>More reliable detection of people</td> <td>Fast (1)</td> </tr> <tr> <td>Reliable vehicle detection</td> <td>Normal (2)</td> </tr> <tr> <td>Reliable differentiation between vehicles & people</td> <td>Slow (3)</td> </tr> </tbody> </table>	Behavior	Setting	More reliable detection of people	Fast (1)	Reliable vehicle detection	Normal (2)	Reliable differentiation between vehicles & people	Slow (3)	✓
Behavior	Setting											
More reliable detection of people	Fast (1)											
Reliable vehicle detection	Normal (2)											
Reliable differentiation between vehicles & people	Slow (3)											
9	Device Address 1 Address 1 ♦ --- 15 Address 15	If there are several sensors in the vicinity of the remote control (sold separately), these sensors must be set to have different device addresses		X								
RESET	Press the FUNCTION and SETTING simultaneously for about 5s.	Reset the sensor to factory settings. The LED flashes GREEN/RED for approximately 10s.		✓								



Section 9

Programmable Parameters

Programming the HR-Robus with the Robus-RC Remote Control

- To enter programming mode, press the  key on the remote control.
- When programming mode is entered, the RED LED on the sensor flashes slowly (2Hz). If the remote control has been security enabled, the RED LED on the sensor flashes fast (5Hz) and expects you to enter a four-digit security code. Once the correct security code has been entered, the sensor LED flashes slowly (2Hz).
- When one of the “Function Keys”, as illustrated in Table 2, is pressed on the remote control the RED LED flashes quickly (5Hz) indicating that a numeric “Setting” value is expected.
- Numeric values can then be entered to change the “Setting” of the function selected in 3 above. The GREEN LED will flash the same number of times as the number pressed on the remote control to indicate that the setting has been registered in the sensor. The +/- keys can also be used to increase or decrease some settings as indicated in Table 2.
- Current settings of any function can be checked by pressing the function key in question followed by ? key.
- To exit programming mode, press the  key twice.

Setting a four digit code for the Robus-RC Remote Control the first time

- Press the  key followed by the  key on the remote control. The RED LED on the sensor should flash fast (5Hz).
- Enter a four digit security code of your choice and memorize it. The sensor will return to its normal operating state as indicated by the GREEN LED on the sensor.
- To enter programming mode, press the  keys on the remote control. The RED LED will flash quickly (5Hz) on the sensor. Enter the security code on the remote control to enter parameterization mode which is indicated by a slow flashing LED (2Hz). If you enter the incorrect security code, the sensor exits programming mode and returns to its normal operating state as indicated by the GREEN LED.
- NOTE:** After a sensor power reset, no security code is required to unlock the sensor for 30 minutes.

HR-Robus

Industrial Door Microwave Motion Sensor

INSTALLATION INSTRUCTIONS

Changing the four digit security code for the Robus-RC Remote Control

1. While in programming mode, press the The RED LED on the sensor should flash fast (5Hz) indicating the sensor is waiting for a new four-digit security code to be entered
2. Within 60 seconds, enter a new four-digit security code.

Other Functions:

1. Locking the IR Interface: Press the key once. The RED LED on the sensor should flash fast (5Hz). Press the “9” key to lock the sensor. The remote control can then only be used within the first 60 seconds after power ON.

NOTE: While in programming mode, press followed by “0” to clear the security code or lock.

TABLE 2

Programmable Parameters: Using Robus-RC Remote Control (sold separately)

± parameters can be adjusted using + and - keys.

FUNCTION KEY	FUNCTION	SETTINGS Number of green LED flashes indicate the setting for each function	DESCRIPTION	SETTING RECOMMENDATIONS																																																		
	Unlock remote control		Unlock remote control to begin sensor programming																																																			
x 2	Lock remote control		Lock the remote control once programming is finished																																																			
SENS	Sensitivity ±	0 Smallest Detection Area --- 5 Medium Detection Area ♦ --- 9 Largest Detection Area	Increase or decrease the size of the detection area	Installation Height Sensor Housing Angle <table border="1"> <thead> <tr> <th></th> <th>15°</th> <th>30°</th> <th>45°</th> <th>>45°</th> </tr> </thead> <tbody> <tr> <td>7m</td> <td>8</td> <td>4</td> <td>2</td> <td>1</td> </tr> <tr> <td>5m</td> <td>6</td> <td>6</td> <td>3</td> <td>1</td> </tr> <tr> <td>3.5m</td> <td>6</td> <td>5</td> <td>4</td> <td>1</td> </tr> <tr> <td>2.5m</td> <td>4</td> <td>4</td> <td>4</td> <td>1</td> </tr> </tbody> </table>		15°	30°	45°	>45°	7m	8	4	2	1	5m	6	6	3	1	3.5m	6	5	4	1	2.5m	4	4	4	1																									
	15°	30°	45°	>45°																																																		
7m	8	4	2	1																																																		
5m	6	6	3	1																																																		
3.5m	6	5	4	1																																																		
2.5m	4	4	4	1																																																		
CAR	Vehicle Detection ±	1 Low 2 Medium ♦ 3 High		Installation Height Sensor Housing Angle <table border="1"> <thead> <tr> <th></th> <th>15°</th> <th>30°</th> <th>45°</th> <th>>45°</th> </tr> </thead> <tbody> <tr> <td>7m</td> <td>1</td> <td>2</td> <td>2</td> <td>1</td> </tr> <tr> <td>5m</td> <td>1</td> <td>2</td> <td>2</td> <td>2</td> </tr> <tr> <td>3.5m</td> <td>1</td> <td>2</td> <td>2</td> <td>3</td> </tr> <tr> <td>2.5m</td> <td>1</td> <td>2</td> <td>2</td> <td>3</td> </tr> </tbody> </table>		15°	30°	45°	>45°	7m	1	2	2	1	5m	1	2	2	2	3.5m	1	2	2	3	2.5m	1	2	2	3																									
	15°	30°	45°	>45°																																																		
7m	1	2	2	1																																																		
5m	1	2	2	2																																																		
3.5m	1	2	2	3																																																		
2.5m	1	2	2	3																																																		
PER	Human Presence Detection ±	1 Min ♦ --- 7 Max	When a value of 1 is chosen, cross-traffic suppression is deactivated. When values between 2-7 are chosen, cross-traffic suppression is activated.	Installation Height Detection without cross-traffic suppression Sensor Housing Angle <table border="1"> <thead> <tr> <th></th> <th>15°</th> <th>30°</th> <th>45°</th> <th>>45°</th> </tr> </thead> <tbody> <tr> <td>7m</td> <td>1</td> <td>1</td> <td>1</td> <td>1</td> </tr> <tr> <td>5m</td> <td>1</td> <td>1</td> <td>1</td> <td>1</td> </tr> <tr> <td>3.5m</td> <td>1</td> <td>1</td> <td>1</td> <td>1</td> </tr> <tr> <td>2.5m</td> <td>1</td> <td>1</td> <td>1</td> <td>1</td> </tr> </tbody> </table> Installation Height Detection with cross-traffic suppression Sensor Housing Angle <table border="1"> <thead> <tr> <th></th> <th>15°</th> <th>30°</th> <th>45°</th> <th>>45°</th> </tr> </thead> <tbody> <tr> <td>7m</td> <td>4-7</td> <td>2-7</td> <td>2-7</td> <td>2-7</td> </tr> <tr> <td>5m</td> <td>4-7</td> <td>4-7</td> <td>4-7</td> <td>4-7</td> </tr> <tr> <td>3.5m</td> <td>4-7</td> <td>4-7</td> <td>6-7</td> <td>6-7</td> </tr> <tr> <td>2.5m</td> <td>4-7</td> <td>6-7</td> <td>6-7</td> <td>6-7</td> </tr> </tbody> </table>		15°	30°	45°	>45°	7m	1	1	1	1	5m	1	1	1	1	3.5m	1	1	1	1	2.5m	1	1	1	1		15°	30°	45°	>45°	7m	4-7	2-7	2-7	2-7	5m	4-7	4-7	4-7	4-7	3.5m	4-7	4-7	6-7	6-7	2.5m	4-7	6-7	6-7	6-7
	15°	30°	45°	>45°																																																		
7m	1	1	1	1																																																		
5m	1	1	1	1																																																		
3.5m	1	1	1	1																																																		
2.5m	1	1	1	1																																																		
	15°	30°	45°	>45°																																																		
7m	4-7	2-7	2-7	2-7																																																		
5m	4-7	4-7	4-7	4-7																																																		
3.5m	4-7	4-7	6-7	6-7																																																		
2.5m	4-7	6-7	6-7	6-7																																																		
OCAR	Vehicle Presence Relay	4 Vehicle forward ♦ 5 Vehicle backwards 6 Vehicle forward/backwards 7 Person/vehicle forward 8 Person/vehicle backwards 9 Person/vehicle forwards/backwards																																																				

TABLE 2 - (continued)

Programmable Parameters: Using Robus-RC Remote Control (sold separately)

± parameters can be adjusted using + and - keys.

FUNCTION KEY	FUNCTION	SETTINGS Number of green LED flashes indicate the setting for each function	DESCRIPTION	SETTING RECOMMENDATIONS								
OPER	Human Presence Relay	1 Person forward ♦ 2 Person backwards 3 Person forward/backwards 4 Vehicle forward 5 Vehicle backwards 6 Vehicle forwards/backwards	Unlock remote control to begin sensor programming Lock the remote control once programming is finished									
TIME	Relay Hold Time ±	0 0.5s 5 10s 1 1s ♦ 6 20s 2 2s 7 30s 3 3s 8 60s 4 5s 9 300s										
OUT	Relay Contact	1 N.O. Contact ♦ 2 N.C. Contact										
STEP	Responsiveness ±	1 Fast 2 Normal ♦ 3 Slow		<table border="1"> <thead> <tr> <th>Behavior</th> <th>Setting</th> </tr> </thead> <tbody> <tr> <td>More reliable detection of people</td> <td>Fast (1)</td> </tr> <tr> <td>Reliable vehicle detection</td> <td>Normal (2)</td> </tr> <tr> <td>Reliable differentiation between vehicles & people</td> <td>Slow (3)</td> </tr> </tbody> </table>	Behavior	Setting	More reliable detection of people	Fast (1)	Reliable vehicle detection	Normal (2)	Reliable differentiation between vehicles & people	Slow (3)
Behavior	Setting											
More reliable detection of people	Fast (1)											
Reliable vehicle detection	Normal (2)											
Reliable differentiation between vehicles & people	Slow (3)											
SET-9	Factory Setting Reset	9 Factory Setting Reset	Reset the sensor to factory settings. The LED flashes GREEN/RED for approximately 10s.									
F2	Permanent Relay Activation (To assist with door maintenance)	1 Automatic ♦ 2 Vehicle & Human relay permanently active 3 Vehicle relay only permanently active 4 Human relay only permanently active 5 Vehicle & Human relay permanently inactive										
?	Query the setting for a function											

HR-Robus

Industrial Door Microwave Motion Sensor

INSTALLATION INSTRUCTIONS

Section 10

Vehicle and Human Presence Detection

Explanation and Examples

The HR-Robus can distinguish between the detection of human and vehicle traffic. This distinction is dependent on the connection and settings of the Vehicle and Human presence relays. Vehicle Detection, Human Presence Detection and Responsiveness functions should also be adjusted as explained in section 8 to ensure detection accuracy.

The HR-Robus has two relay outputs as follows:

Vehicle Presence Relay - which can be set to detect a vehicle only or a vehicle/person.

Human Presence Relay - which can be set to detect a vehicle or a person.

EXAMPLE 1: Door controller with only 1 relay input. Vehicle detection only required.

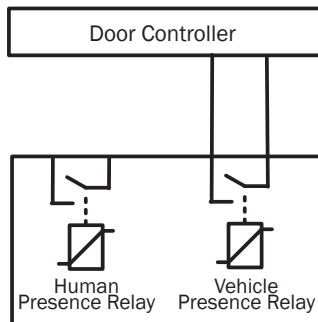
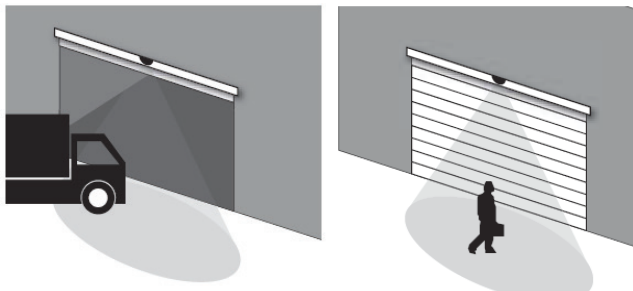

Connect the Vehicle Presence Relay to the door controller and configure the Vehicle Presence Relay setting to (1) Vehicle forward.

Responsiveness should be set to (2) Normal and the vehicle Detection function should be set as per Table 1 of this manual depending on the installation height of the sensor.

EXAMPLE 2: Door Controller with 2 relay input. One to activate the industrial door and one to activate a separate pedestrian access door.

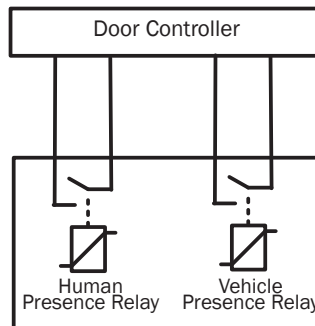

Connect the Vehicle Presence Relay and Human Presence Relay to the door controller. Configure the Vehicle Presence Relay setting to (1) "Vehicle forward". Configure the Human Presence Relay setting to (1) Person forward".

Responsiveness should be set to (2) Normal and the Vehicle Detection and Human Presence Detection functions should be set as per Table 1 of this manual depending on the installation height of the sensor.

EXAMPLE 3: Door Controller with 2 relay input. One set to open the door fully when a vehicle approaches and half-way when a person approaches.

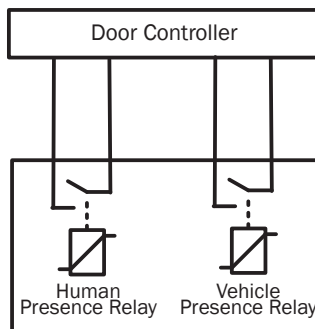

Connect the Vehicle Presence Relay and Human Presence Relay to the door controller. Configure the Vehicle Presence Relay setting to (1) "Vehicle forward". Configure the Human Presence Relay setting to (1) Person forward".

Responsiveness should be set to (2) Normal and the Vehicle Detection and Human Presence Detection functions should be set as per Table 1 of this manual depending on the installation height of the sensor.

HR-Robus

Industrial Door Microwave Motion Sensor

INSTALLATION INSTRUCTIONS

Section 11

Troubleshooting

- FAULT 1: No LED Lit.
CORRECTIVE ACTION: No power supply connected. Device has malfunctioned.
- FAULT 2: Door is detected.
CORRECTIVE ACTION: Tilt the sensor housing away from the door. Reduce the sensitivity setting. Increase Responsiveness. Increase Human Presence Detection.
- FAULT 3: Remote Control does not respond.
CORRECTIVE ACTION: Device is locked. Cycle power to the sensor, the sensor can now be configured without a code for 30 minutes. Remote Control batteries are dead.
- FAULT 4: Person is mistaken for a vehicle.
CORRECTIVE ACTION: Increase the vehicle detection properties. Increase Responsiveness. If only vehicles are to be detected then reduce the sensitivity setting.
- FAULT 5: Vehicle is mistaken for a person.
CORRECTIVE ACTION: Lower the vehicle detection properties. Increase Responsiveness.
- FAULT 6: Object is detected too late.
CORRECTIVE ACTION: Reduce Responsiveness. Increase sensitivity.
- FAULT 7: Object detection is too sensitive.
CORRECTIVE ACTION: Increase Responsiveness. Reduce sensitivity.
- FAULT 8: Transverse movement of people not detected.
CORRECTIVE ACTION: Increase human-presence detection.
- FAULT 9: False door activations caused by rain, vibrations, etc.
CORRECTIVE ACTION: Increase Responsiveness. Increase human presence detection. Reduce sensitivity.

Section 12

System Inspection and Instructions

*******EXTREMELY IMPORTANT*******

After final set-up, test unit(s) completely to ensure that proper coverage has been achieved (width, depth and location of the pattern must be tested).

After the installation and operational check of the system:

1. Place the proper warning labels on the door.
2. Instruct the owner of the door system operation and how to test it. This should be checked on a daily basis.

3. Instruct the owner on what to do if the door or any of its components become damaged.
4. Strongly recommend to the owner that the complete entry be inspected twice a year as part of the service agreement

Section 13

Technical Data

Model.....	HR-Robus
Detection Method	Microwave Technology
Frequency.....	24.150-24.250GHz
Max Installation Height....	23 ft. (7m)
Detection Pattern.....	Adjustable via programming and tilt angle
Detection Angle.....	Adjustable, Vertical, & Slant Angle
Detection Mode.....	Bidirectional, approach-only or depart-only
Power Requirements.....	12 to 28V AC or 12 to 36V DC
Current Consumption.....	50mA @ 24V DC
Power.....	<1W
2 Relay Outputs.....	N.O. or N.C.
Hold Time.....	0.5 sec. to 300 sec. adjustable
Temperature.....	-4 °F to 140 °F (-20 °C to 60 °C)
Operating Humidity.....	Below 90%
Weight.....	0.7 lbs. (320g) 1.43 lbs. (650g)
Size	
w/Mounting Bracket.....	5.16" x 2.87" x 5.35" 131mm(W)x73mm(H)x136mm(D)
Color/Enclosure.....	Polycarbonate

Section 14

Warranty

MS SEDCO guarantees this product to be free from manufacturing defects for three years from date of installation. Unless MS SEDCO is notified of the date of installation, the warranty will be in effect for three years from the date of shipment from our factory. If, during the first three years, this device fails to operate and has not been tampered with or abused, the unit can be returned prepaid to factory and it will be repaired free of charge. After three years, the unit will be repaired for a nominal service charge. **This limited warranty is in lieu of all other warranties expressed or implied, including any implied warranty of merchantability, and no representative or person is authorized to assume for MS SEDCO any other liability in connection with the sale of our products. All warranties are limited to the duration of this written warranty. In no event shall MS SEDCO be liable for any special, incidental, consequential or other damages arising from any claimed breach of warranty as to its products or services.**

