

730-619 Series

Combination Keyswitches and Door Activator Switches

INSTALLATION INSTRUCTIONS

Section 1

General Description

The 730-619 series are two switches in one. The keyswitch and door activator switch can be set up to work independently of each other or the keyswitch can turn off/on the door activator switch, thus, providing an economical way to secure the activation of an automatic door after hours.

Both the keyswitch and door activator switch share a 4 1/2" square back plate, making it easy to install to any 2-gang electrical box or MS Sedco #1015 surface mounting box.

The keyswitch is DPDT and comes in two operating functions:

730-A: Maintained Contact Switch

730-B: Momentary Contact Switch

The door activator switch is available with any of the 619 series narrow style switch face plates.

Section 2

Basic Installation

- 1) Install the 2-gang electrical box (purchased separately) in its intended location.
- 2) Insert the mortised cylinder (purchased separately) through the 3/4" shoulder ring and attach it to the keyswitch frame with the supplied cylinder ring nut (Fig. 1).



NOTICE: The keyswitch frame will accommodate mortised cylinder depths from 1 1/8" to 1 1/4" with standard cams (Fig. 2).

- 3) Install the cover plate over the toggle switch and cylinder and secure it with the three 6-32 x 3/16" screws provided, completing the keyswitch assembly (Fig. 3).



WARNING: For proper operation ensure that the toggle lever of the switch fits through the oblong hole in the cover plate and moves freely.

- 4) Make the appropriate electrical connections to the 6 conductor wire harness and plug the harness into its connector on the back of the keyswitch assembly (Fig. 4).



NOTICE: The keyswitch and door activator switch can be wired independent of each other or a maintained keyswitch can be wired to turn the door activator switch off/on.

- 5) Secure the keyswitch assembly to one side of the 2-gang electrical box with the two 6-32 x 1" screws provided and adjust assembly for squareness.



NOTICE: If the electrical box is mounted too deep in the wall, it may be necessary to shim out the keyswitch assembly in order to mount the 4 1/2" back plate/door activator switch assembly properly.

- 6) Remove the face plate from the door activator switch assembly.
- 7) Make the appropriate electrical connections to the switch contacts located on the micro-switch.

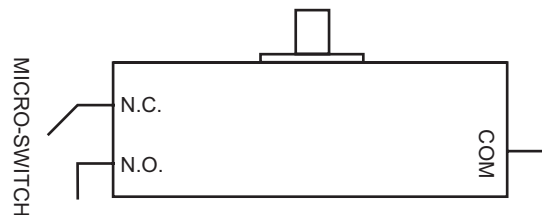

- 8) Attach the 4 1/2" back plate into the 2-gang electrical box with the door activator switch beside the previously installed keyswitch assembly using two 6-32 x 1" screws provided. Next, attach the 4 1/2" back plate to the keyswitch assembly with two spanner head 6-32 x 1/4" screws provided (Fig. 5).
- 9) Reattach the face plate to the door activator switch assembly using two 6-32 x 1/4" screws provided (Fig. 5).

Section 3

Technical Data

Toggle Switch.....	UL Listed
	Double Pull Double Throw (DPDT)
	Maintained or Momentary Contact
Rating.....	1 Amp
Door Activator Micro-switch.....	UL Listed
	Single Pull Double Throw (SPDT)
	Momentary Contact
Rating.....	15A @ 125V AC

730-619 Series

Combination Keyswitches and Door Activator Switches

INSTALLATION INSTRUCTIONS

FIGURE 1

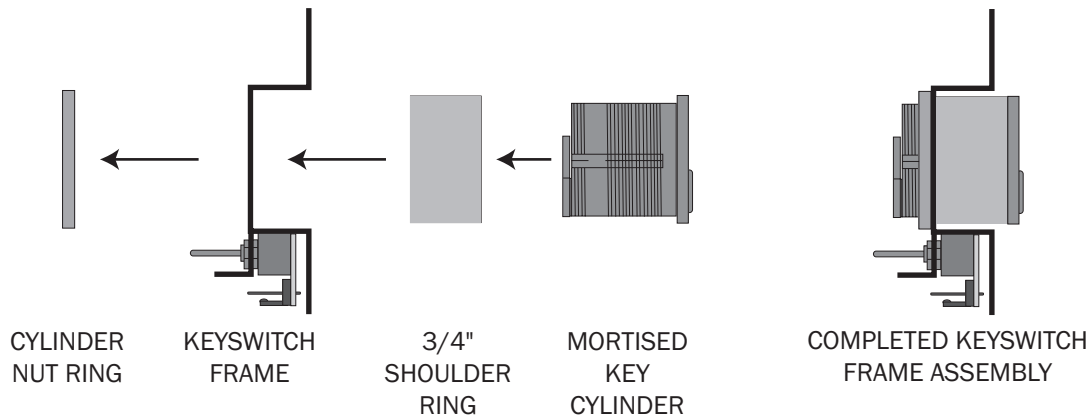

FIGURE 2

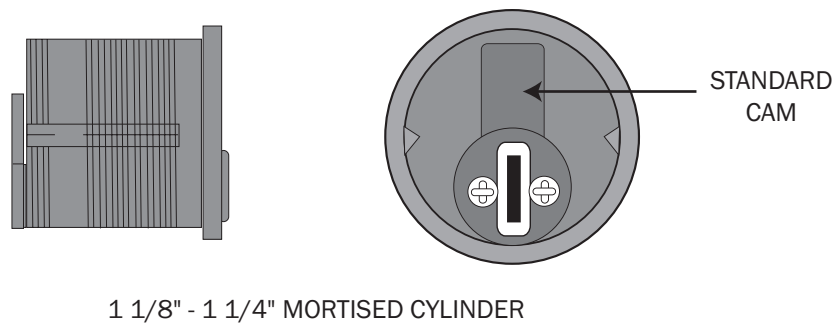
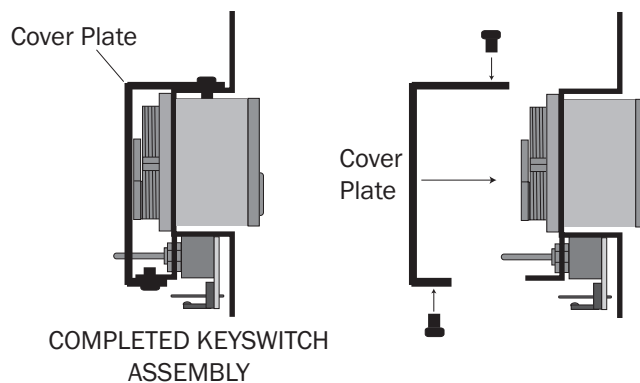

FIGURE 3



WARNING: For proper operation, ensure that the toggle lever of the switch fits through the oblong hole in the cover plate and moves freely.

FIGURE 4

MAINTAINED ACTION (730-A, 730-AL, 730-AN)

When the key is turned to set the switch in the "CLOCKWISE" position, the contacts are configured as follows:

SWITCH POLE #1	SWITCH POLE #2
Yellow—CLOSED	Blue—CLOSED
White—COM	Brown—COM
Black—OPEN	Violet—OPEN

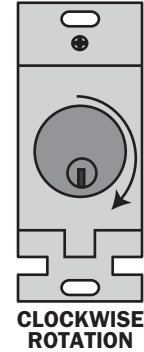

When the key is turned to set the switch in the "COUNTERCLOCKWISE" position, the contacts are configured as follows:

SWITCH POLE #1	SWITCH POLE #2
Yellow—OPEN	Blue—OPEN
White—COM	Brown—COM
Black—CLOSED	Violet—CLOSED

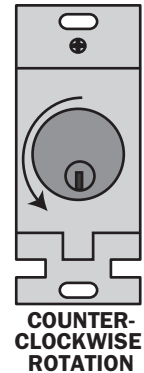

MOMENTARY ACTION (730-B, 730-BL, 730-BN)

SWITCH POLE #1	SWITCH POLE #2
Yellow—N.O.	Blue—N.O.
White—COM	Brown—COM
Black—N.C.	Violet—N.C.

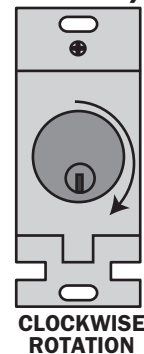

730-619 Series

Combination Keyswitches and Door Activator Switches

INSTALLATION INSTRUCTIONS

FIGURE 5



WARNING: Attach to the KEYSWITCH ASSEMBLY with 2: 6-32 x 1/4" spanner screws ONLY. Longer screws will damage the printed circuit board.

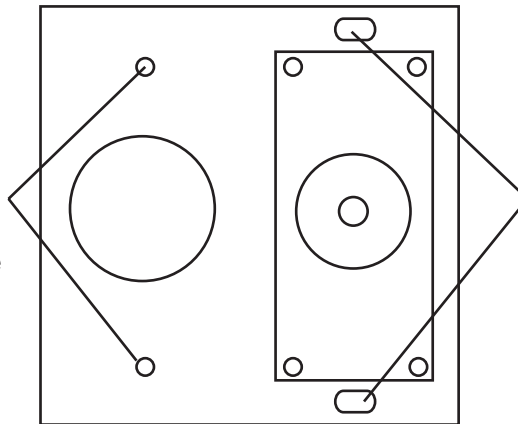

Attach to 2-gang electrical box with 2: 6-32 x 1" screws.

