

425 Series

Narrow Style Door Activator Button Switches

INSTALLATION INSTRUCTIONS

Section 1

General Description

The 425 series door activator switches are designed to provide unobtrusive, reliable activation of any automatic door at the doorframe. The unique design of these switches includes interchangeable self-sticking mylar labels for customizing the face plate.

Section 2

Basic Installation

- 1) Make the required cutout in the door frame.

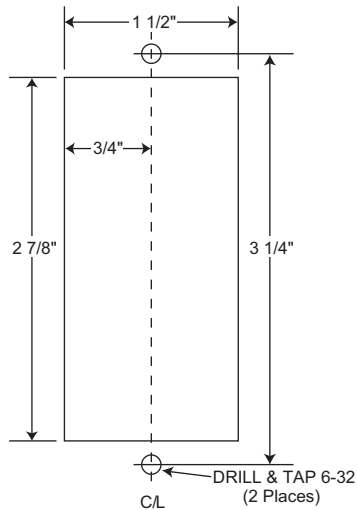

- 2) Remove the face plate from the button switch assembly.
- 3) Connect the necessary signal wires to the appropriate switch contacts on the micro-switch—standard connections are COM and N.O.

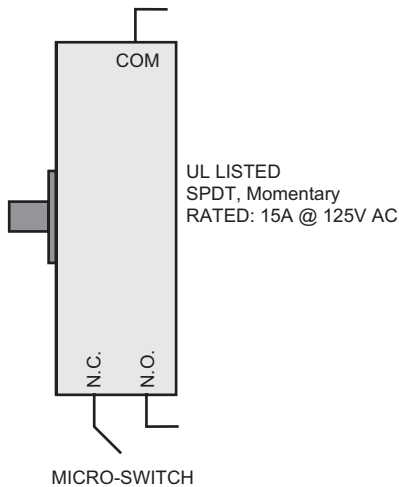

- 4) Attach the button switch assembly in the cutout prepared in step 1 with the 6-32 x 5/8" screws provided. **Do Not Over Tighten!**

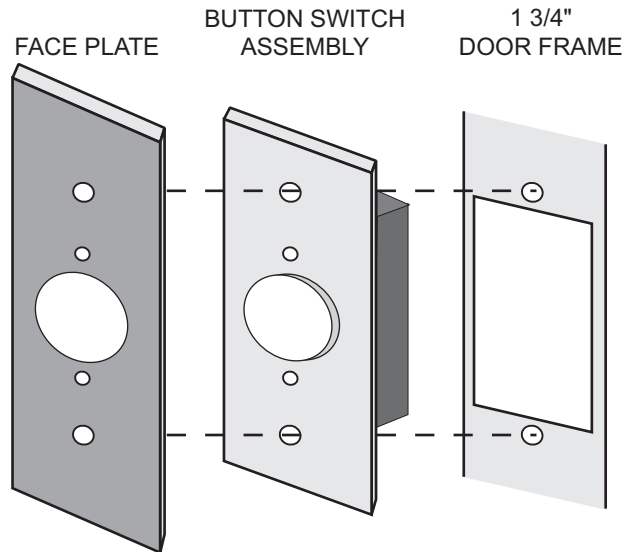

1 1/2" SELF-STICKING
MYLAR FACE PLATE LABELS

- 5) Reinstall the face plate (6-32 x 1/2" screws provided).
- 6) Attach desired label to face plate.



NOTICE: For surface mounting applications, order the 1106 surface mount box.

For further technical assistance, contact the factory at 1-800-842-2545.