

# 1078 Series

## Low Profile Door Activator Switches

## INSTALLATION INSTRUCTIONS

### Section 1

#### General Description

The 1078 series low profile door activator switches are designed to provide reliable activation of any automatic door. The unique design of these switches includes a 2" x 3" active face plate mounted flush within the back plate assembly. The complete switch assembly projects only 1/4" from the wall. The face plates are available in different finishes and legends (contact the factory for more information)

### Section 2

#### Basic Installation

- 1) Mount a standard 2-gang electrical box in its intended location.



CAUTION: Mount the electrical box flush with to 1/8" recessed in from the finished wall surface.

- 2) Connect the necessary signal wires to the appropriate switch contacts on the micro-switch—standard connections are COM and N.O.

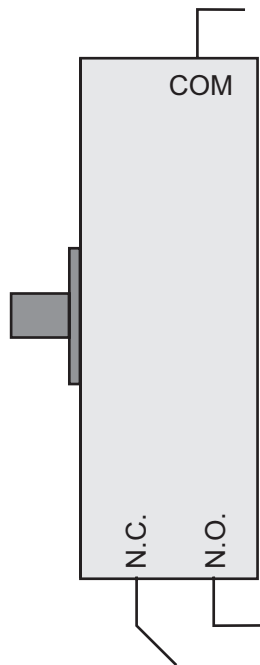

UL LISTED  
SPDT, Momentary  
RATED: 15A @ 125V AC

MICRO-SWITCH

- 3) Attach the switch assembly to the electrical box with the 6-32 x 1" screws provided. **Do Not Over Tighten!**

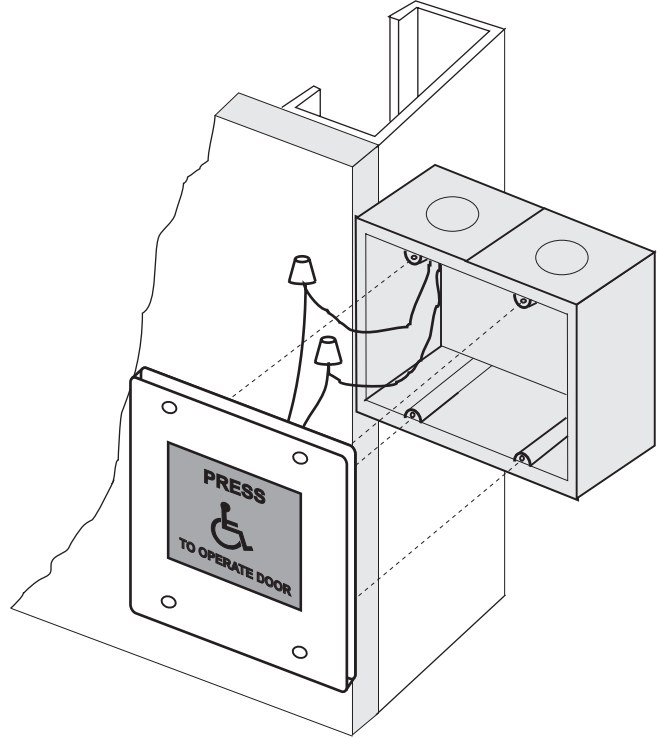

NOTICE: For surface mounting applications, order the 1015 surface mount box.



NOTICE: For radio control applications, order the TX-323 transmitter with surface mount box.



NOTICE: For applications where a greater level of weather protection is desired, order either the RB kit or WR kit.

For further technical assistance, contact the factory at 1-800-842-2545.